

A**S221-P/1/14**

2 / 4

**30min**

A	B	C (mm)		D
1	S221-357	1399	230	1/1
2	S221-453	1400	120	1/1

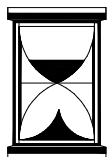
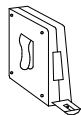
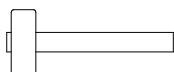
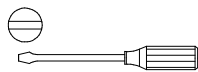
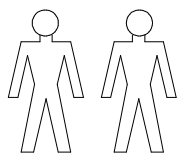
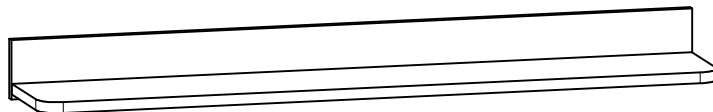
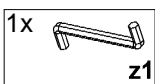
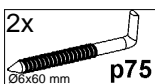
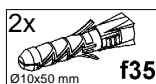
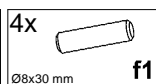
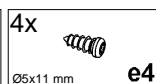
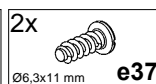
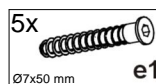
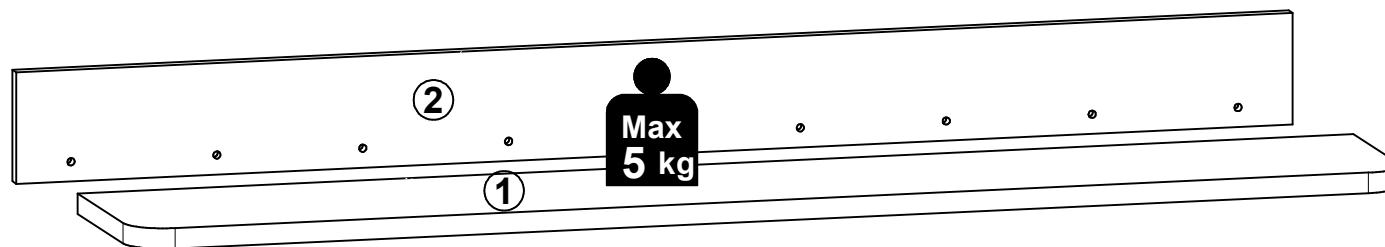

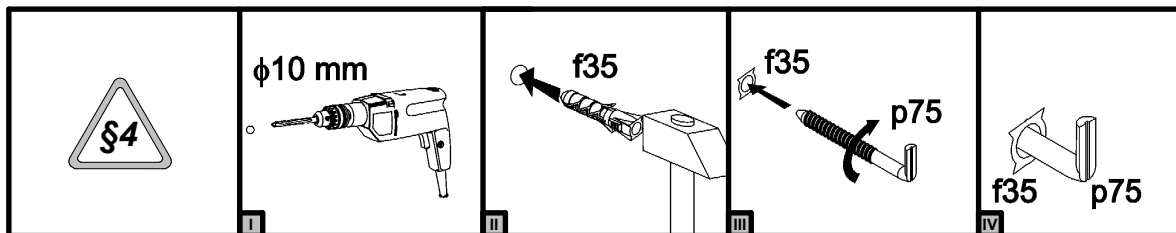
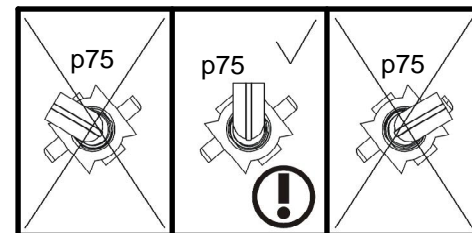
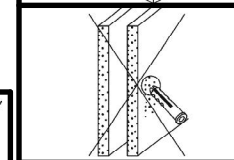
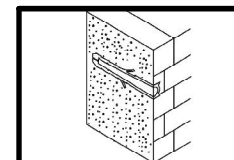
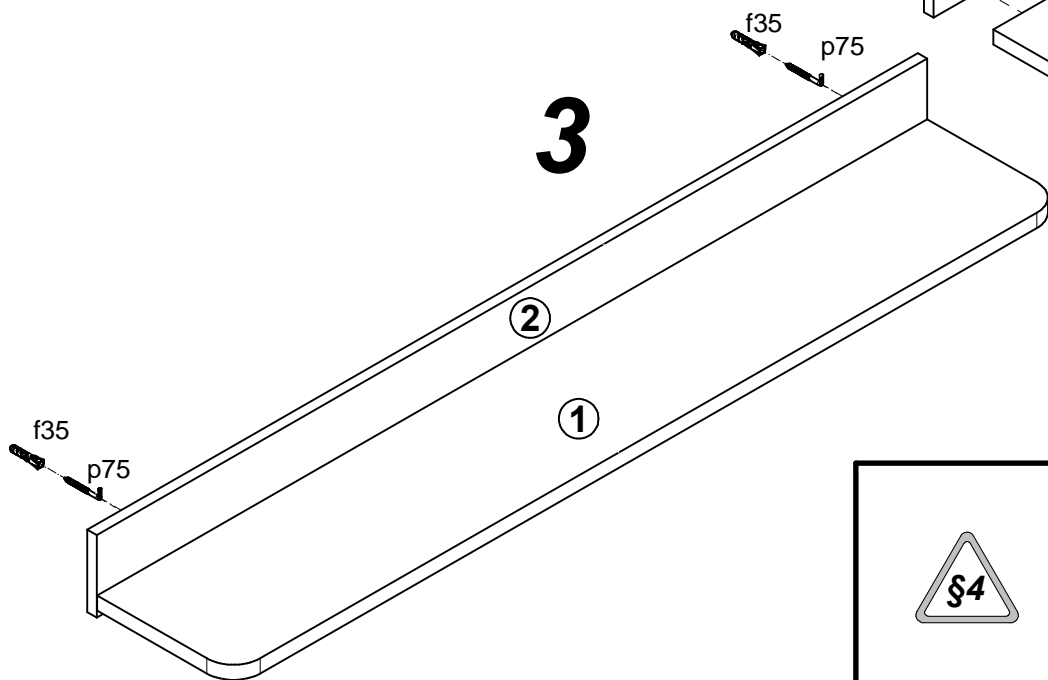
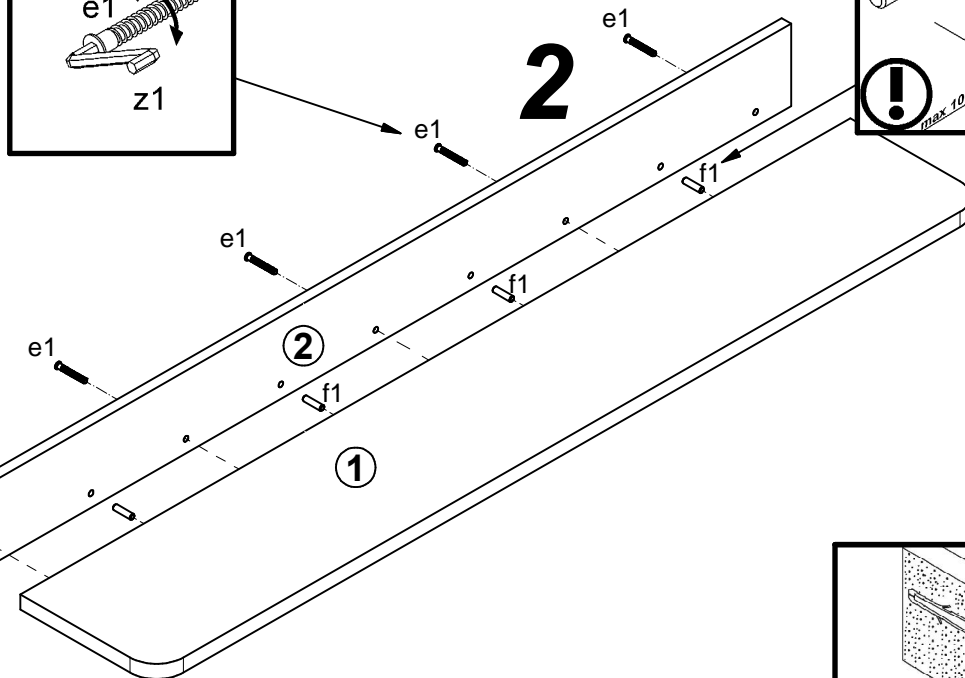
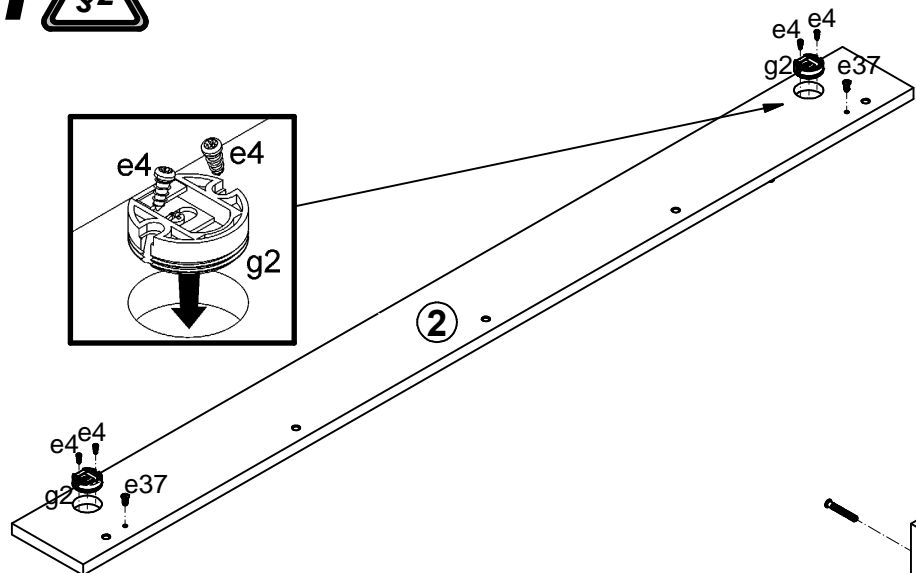
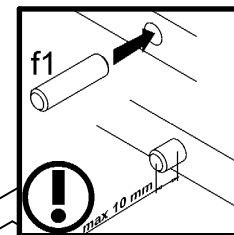
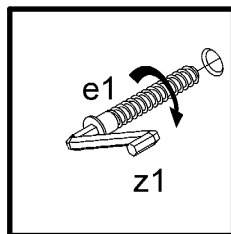
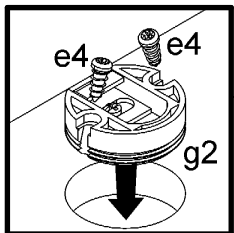

4

