

A	B	C	D	
1	S372-1001	1184	398	1/1
2	S372-1002	1184	398	1/1
3	S372-2001	817	400	1/1
4	S372-2002	817	400	1/1
5	S372-3001	384	396	1/1
6	S372-3002	384	396	1/1
7	S372-4001	384	384	1/1

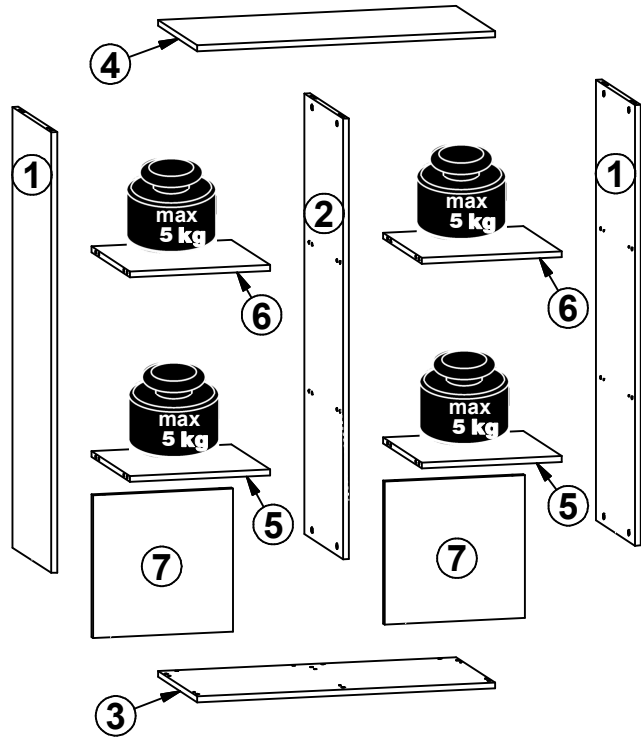

A

B

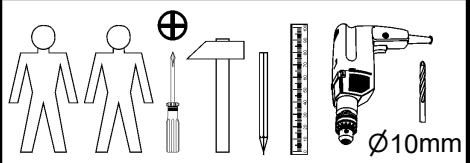
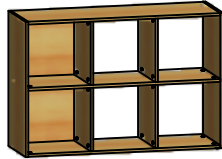
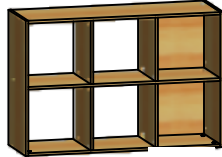
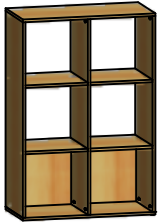

36x Ø8x30 mm f1	1x Ø10x50 mm f35	6x Ø20x3mm k103	1x 86x21x15/1,5 n14\2	1x Ø5x60 mm p17	2x Ø3,5x16 mm p38	28x Ø15x12 mm #16 r1	4x r10	20x 20/11 r42
28x Ø20mm s68								

1 §2

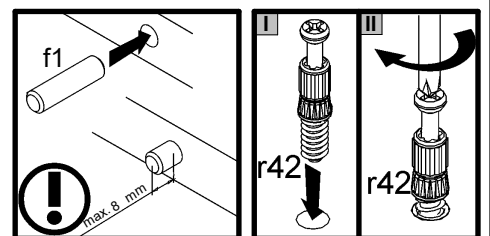
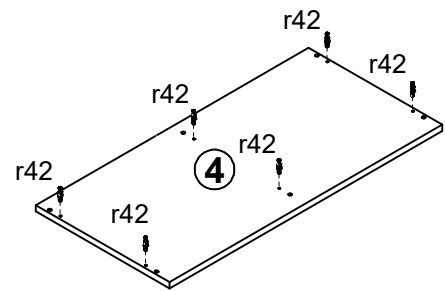
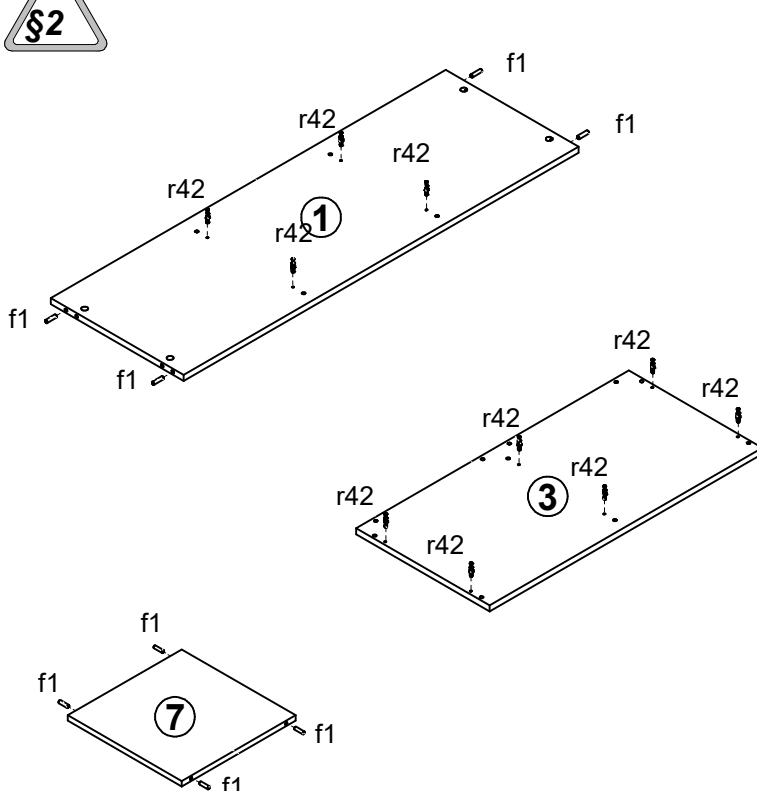

# 2

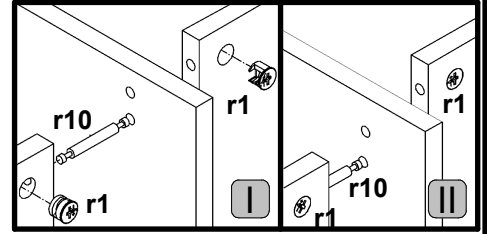
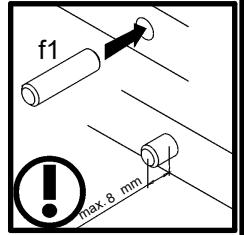
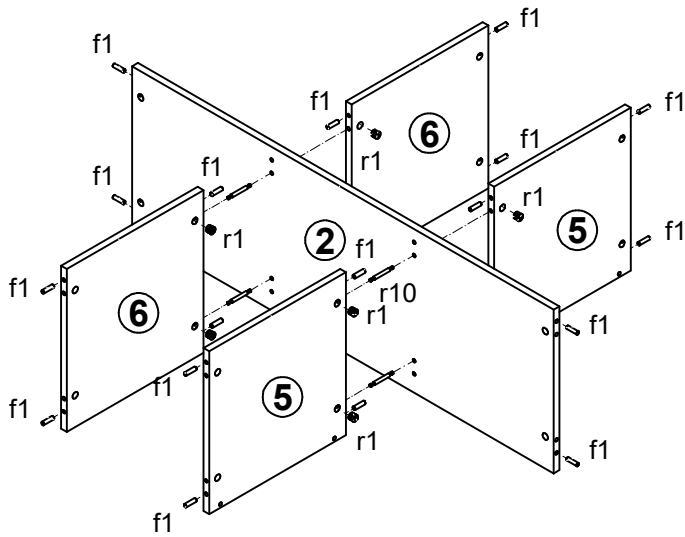

# 3

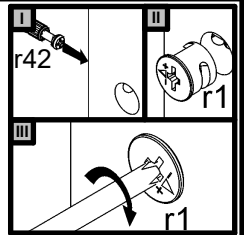
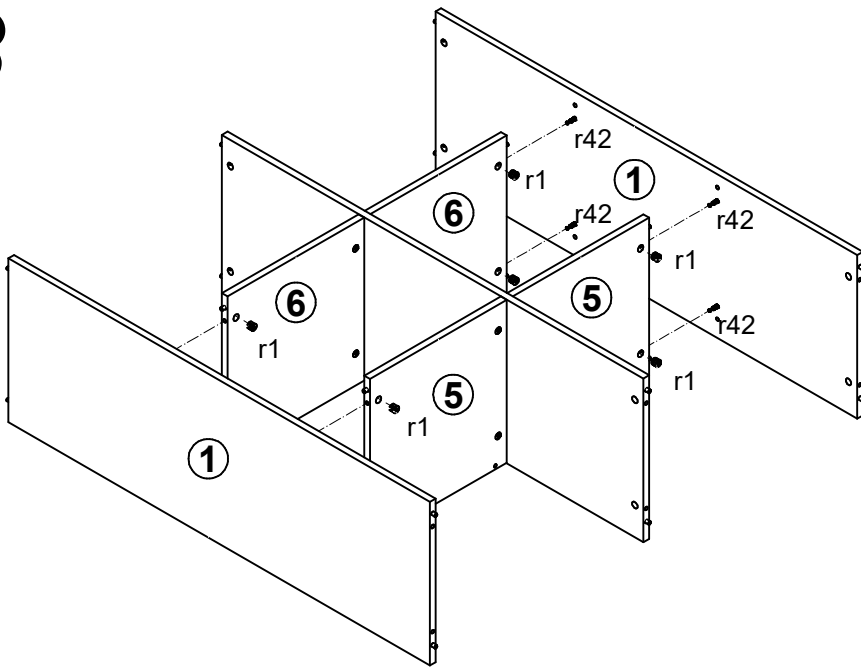

# 4

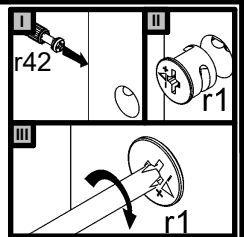
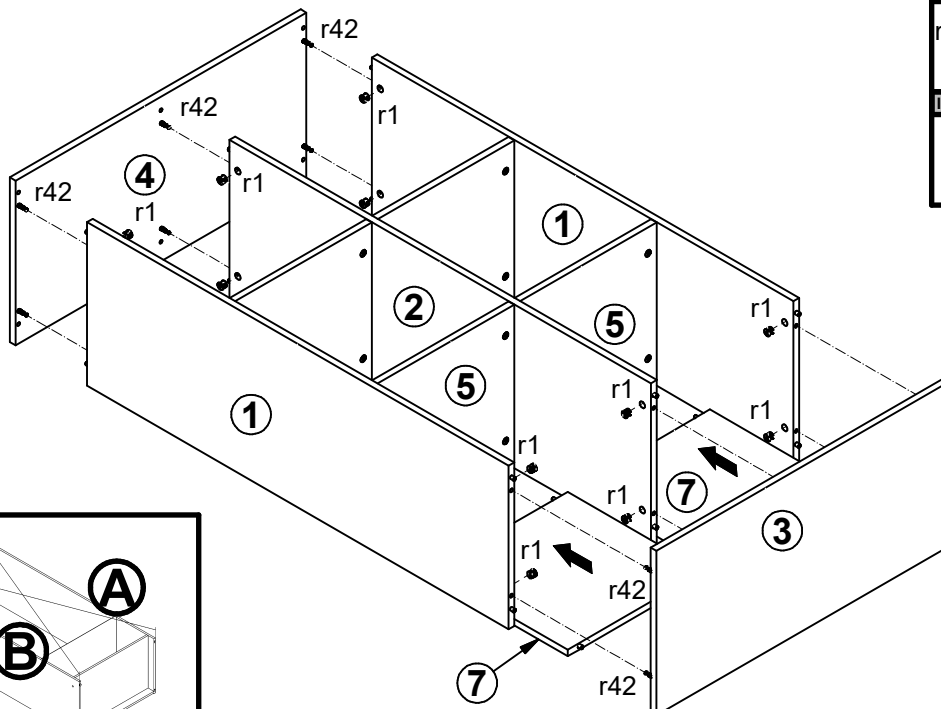

A=B

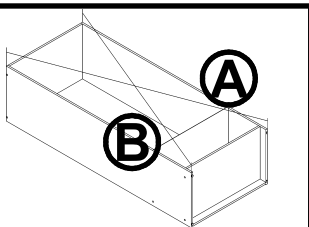

5

A

B

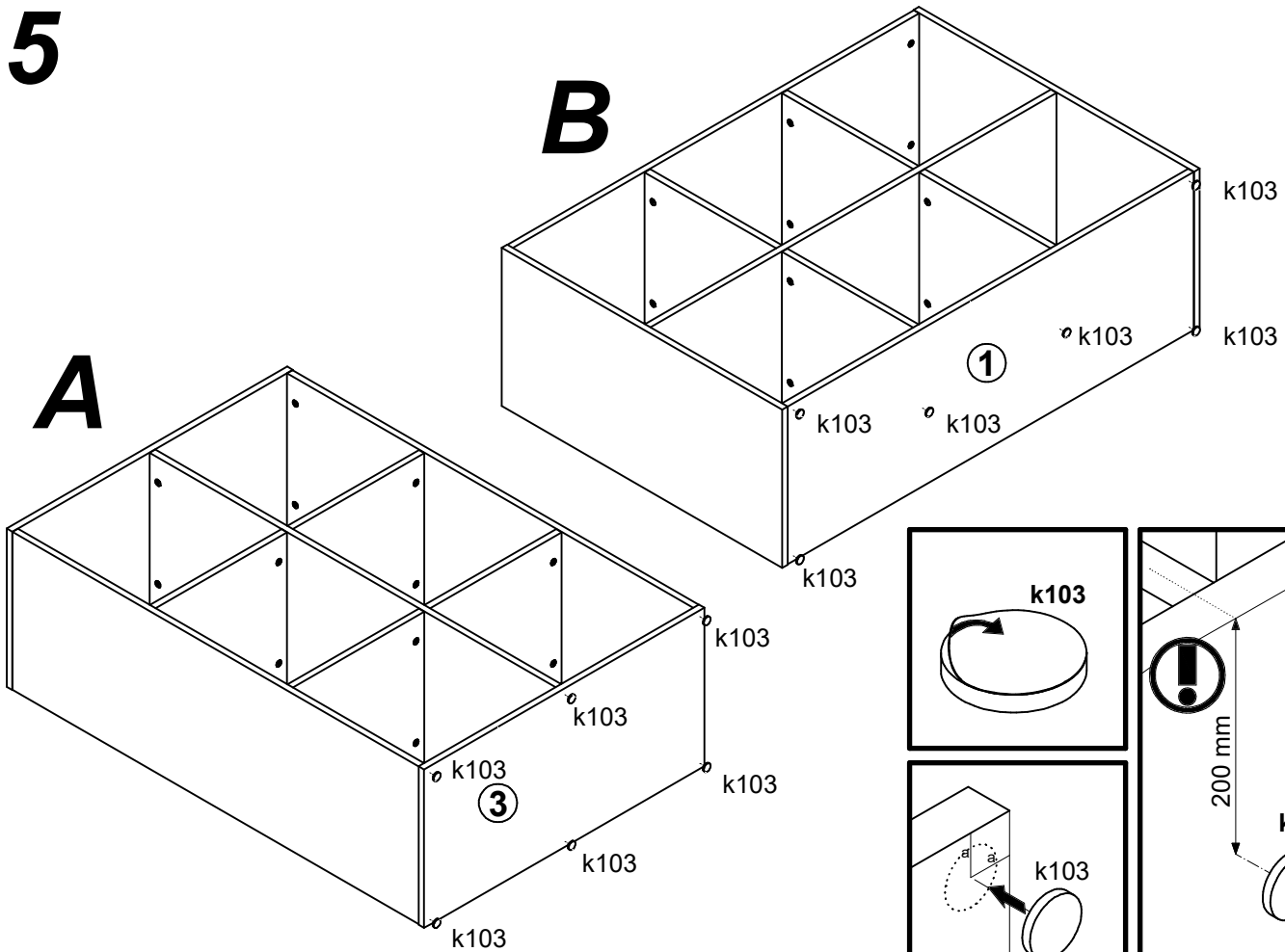

6

