

A	B	C (mm)		D
1	S330-010	1398	590	1/1
2	S330-208	590	300	1/1

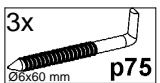

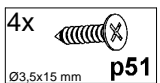
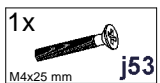
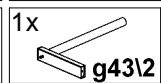
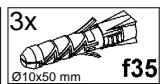
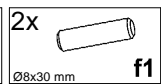
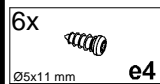
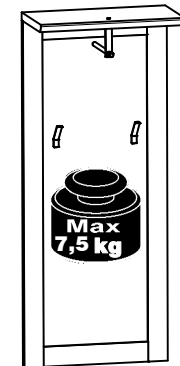

3

1

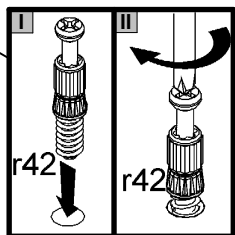
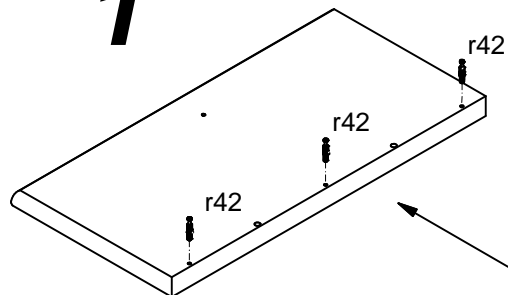

2

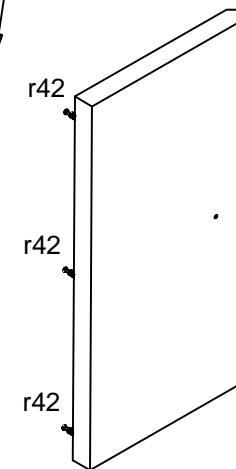
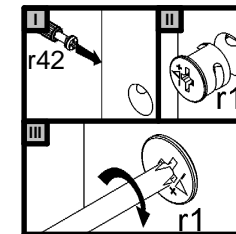
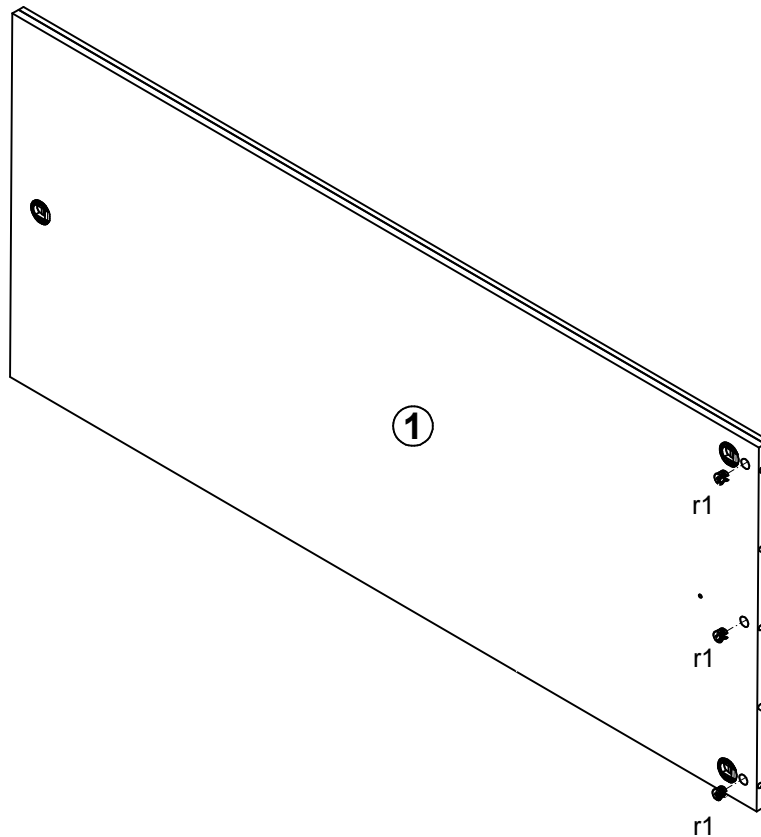
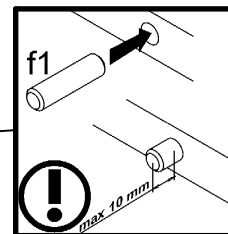
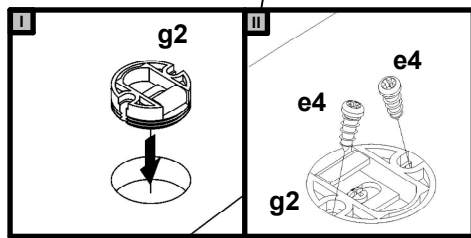
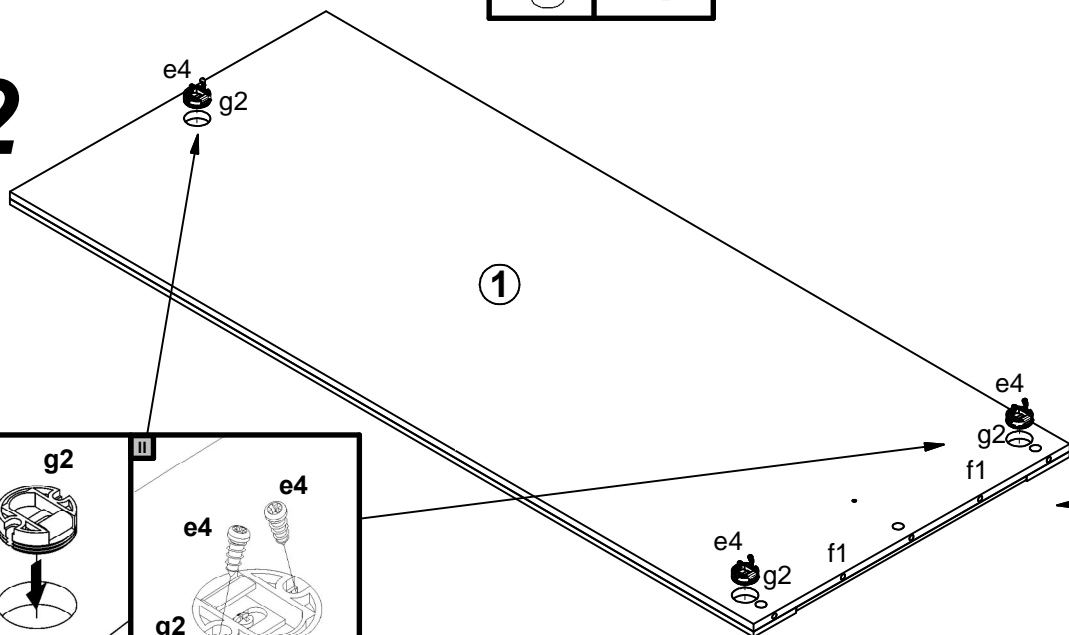

4

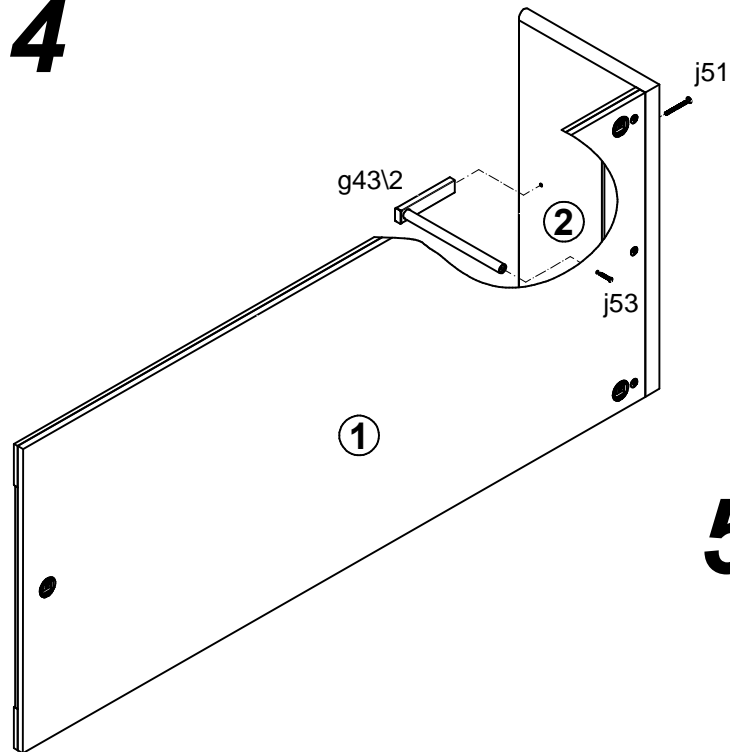

5

